

2 WAY CONTROL VALVE WITH ALUMINUM OPERATOR

Automation
Simplified...



Solenoid Valve

Angle Seat Valve

Rotary Coupling

Pneumatic Directional Control Valve

Actuator

Cylinder

One Touch Fitting

Ball Valve

Butterfly Valve

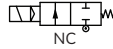

Valve Specifications

Port :	½" (Available in BSP / BSPT / NPT)			
End Connection :	Screwed			
Body Material :	Brass Forge			
Seal Material :	Nitrile (NBR)	EPDM	Viton (FKM)	PTFE
Media Temp :	-30°C to 90°C	-10°C to 140°C	-10°C to 180°C	-10°C to 180°C
Circumstance Temp :	-10°C to 70°C			
Media :	Air, Water, Chemical, Gas, Oil, Diesel, Kerosene, LPG.			
Main Features :	Internal Parts Are In Superior Corrosion Resistance Steel.			

Actuator Specifications

Cover :	Aluminium
Control Plate :	Aluminium
Working Pressure	3.5 - 7 Bar
Seal Material	Nitrile

NOTE: Use of filter in the inlet port is recommended.
Specification may change without prior notice.

Technical Data

Valve Model No.	Body Material	Pipe (Inch)	Orifice (mm)	Min. Operating Pressure Kg/cm ²	Max. Operating Pressure Kg/cm ²	Seal & Diaphragm Material	Flow Factor Kv m ³ / hr
CBN205FBNAV0	Brass	½"	12	0	16	NBR / EPDM / VITON / PTFE	2.5

DIMENSIONS (MM)

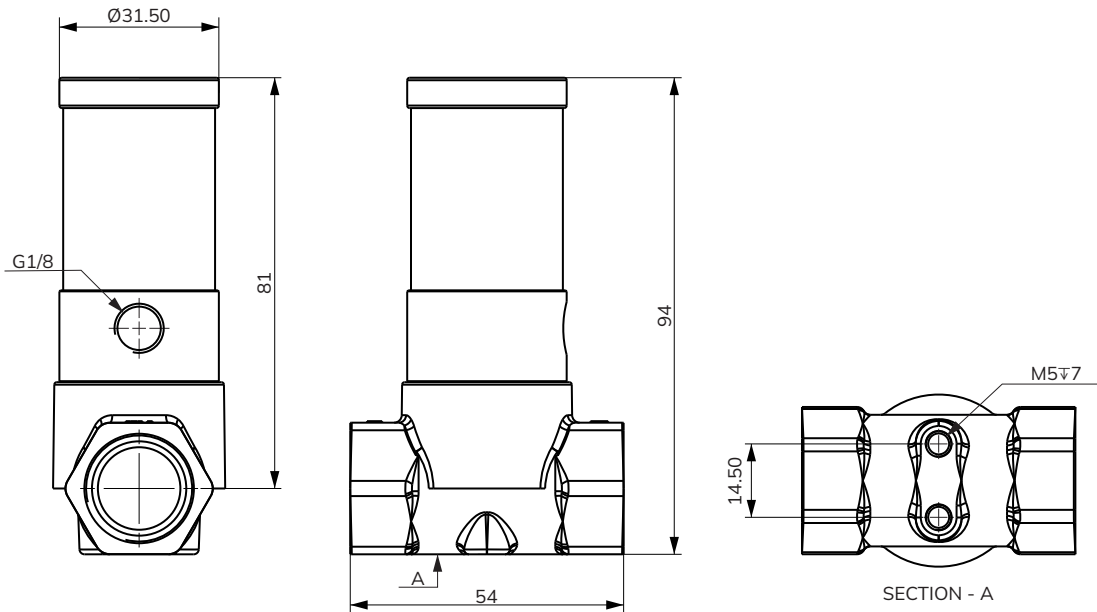

* All dimensions are approx

2 WAY CONTROL VALVE WITH ALUMINUM OPERATOR MODEL IDENTIFICATION CHART

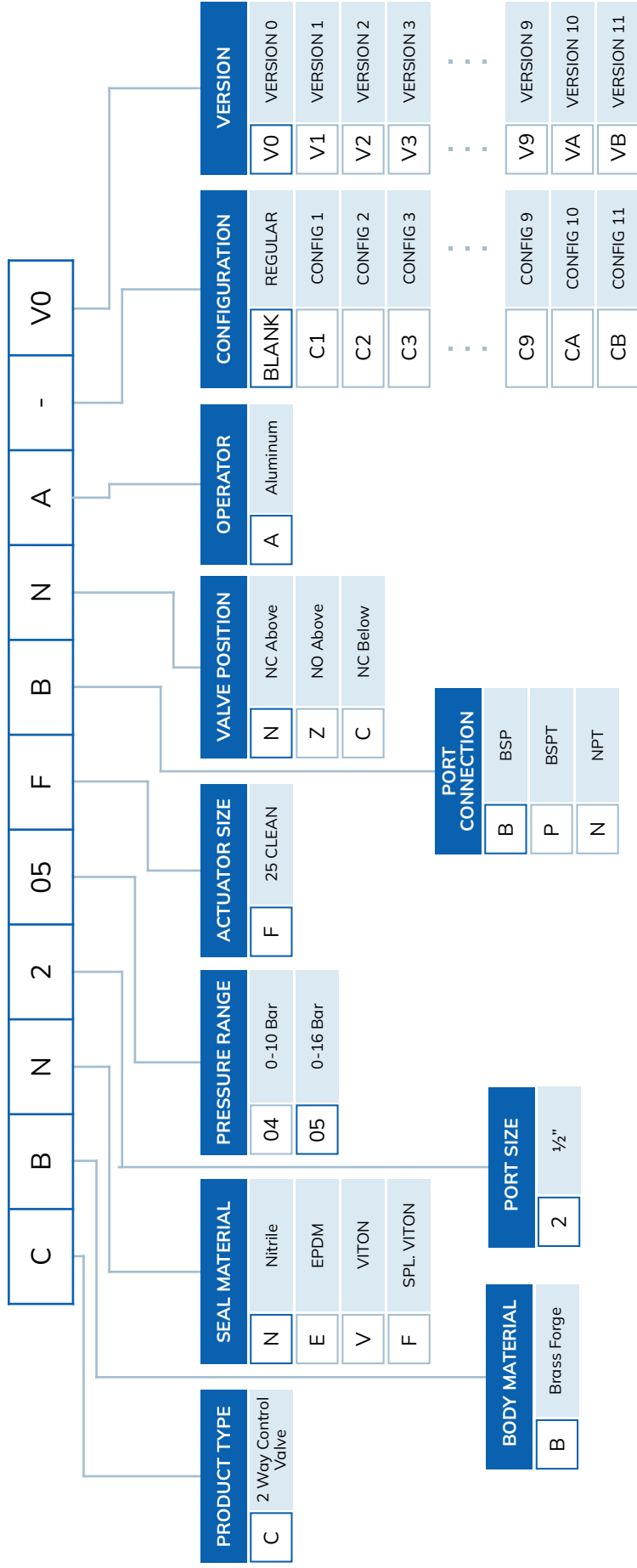

CBN205FBNAVO

1/2" 2 WAY CONTROL VALVE ALUMINUM OPERATOR BRASS-NITRILE-0 TO 16 Bar-25 CLEAN-BSP-NC ABOVE

Note: The above chart is for identification purposes only, and it may not be possible to make all combinations for the above chart.



Global Presence...



Made In India



CONTACT US:

 sales@uflowvalve.com  +91 851 109 8822  www.uflowvalve.com

 Uflow Automation, Ankur Industrial Complex, Survey No: 275/276, Plot No: 31, Nr. Intol Cast Pvt. Ltd. Shapar(Veraval) Dist.: Gujarat (India) - 360 024.